

Investor Conferences

3Q 2022

Sitronix Technology Corp.

矽創電子股份有限公司

8016: TT

Sitronix

Sitronix Confidential. Do Not Copy or Distribute.

免責聲明

- This presentation includes forward-looking statements. All statements, other than statements of historical facts, that address activities, events or developments that Sitronix Corp. expects or anticipates will or may occur in the future (including but not limited to projections, targets, estimates and business plans) are forward-looking statements.
- Sitronix actual results or developments may differ materially from those indicated by these forward-looking statements as a result of various factors and uncertainties, including but not limited to material cost increase, market demand, change in legal, financial and regulatory frameworks, government policies, financial market conditions, and other risks and factors beyond our control.
- Sitronix does not undertake any obligation to publicly update any forward-looking statement to reflect events or circumstances after the date on which any such statement is made or to reflect the occurrence of unanticipated events.

公司簡介

公司名稱	矽創電子股份有限公司
成立日期	1998年7月
資本額	40M USD
董事長暨執行長	毛穎文 Vincent Mao
臺灣證券交易所上市	2003年12月 (8016)



Consolidated

矽創電子

Sitronix

Display Driver IC



Incubator since 2009

矽創集團合併營收

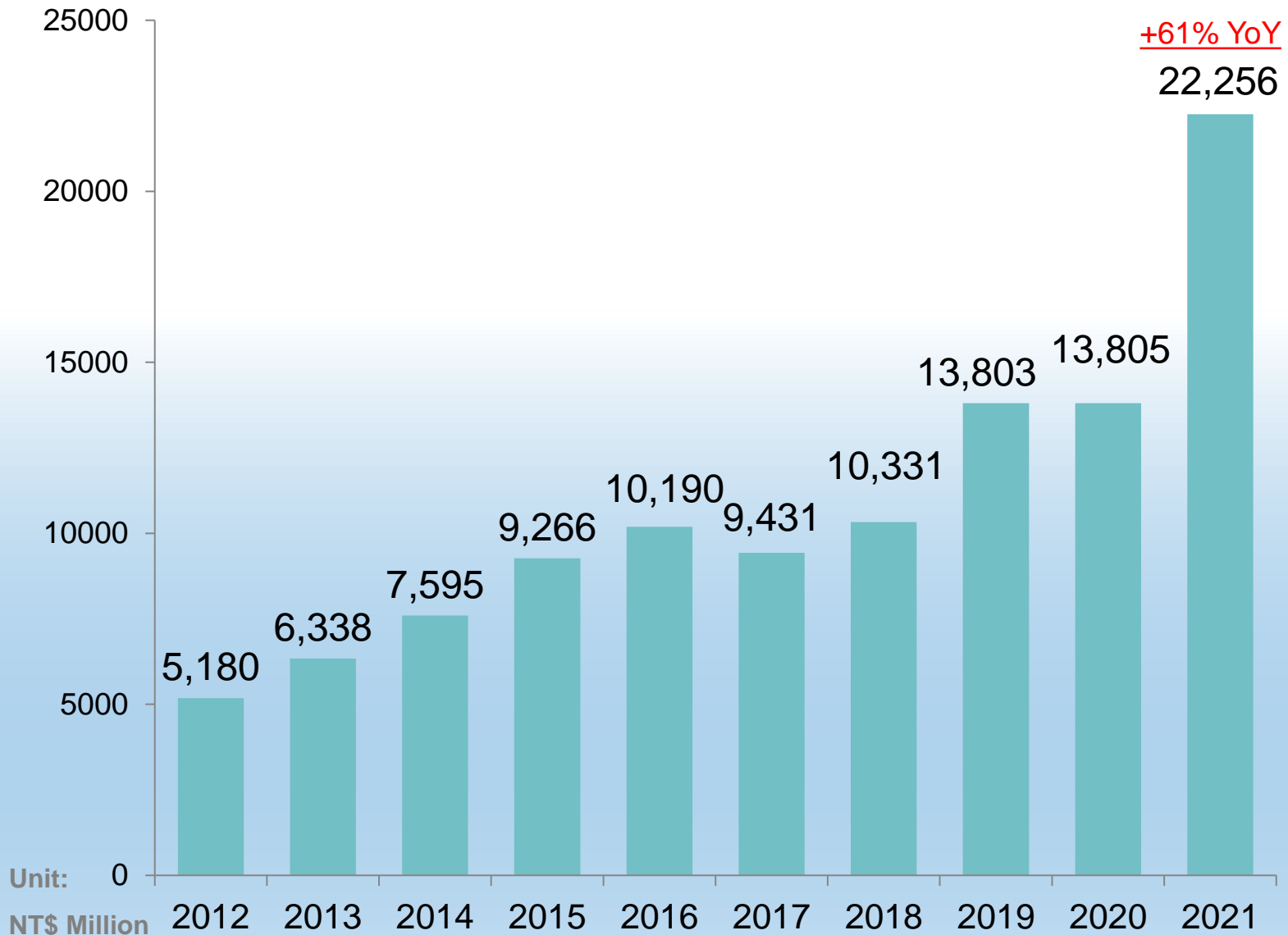

EPS & 毛利趨勢

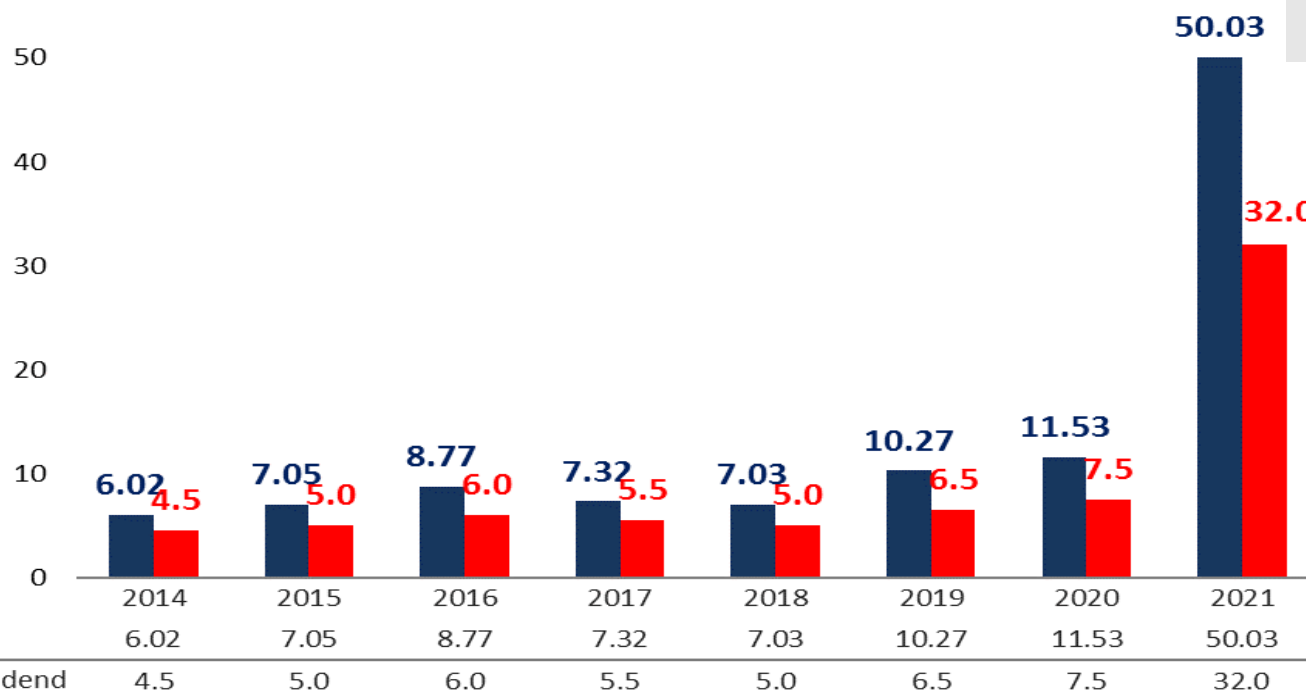
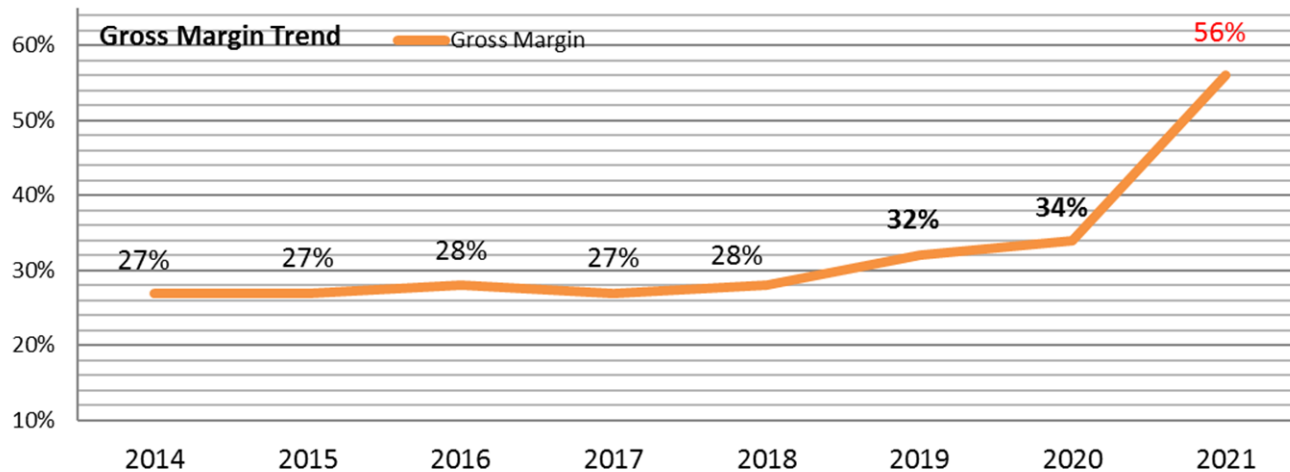

Unit: NT\$
Accounting
standard: IFRS

■ EPS
■ Dividend

合併季營收 & EPS

Quarterly Revenue

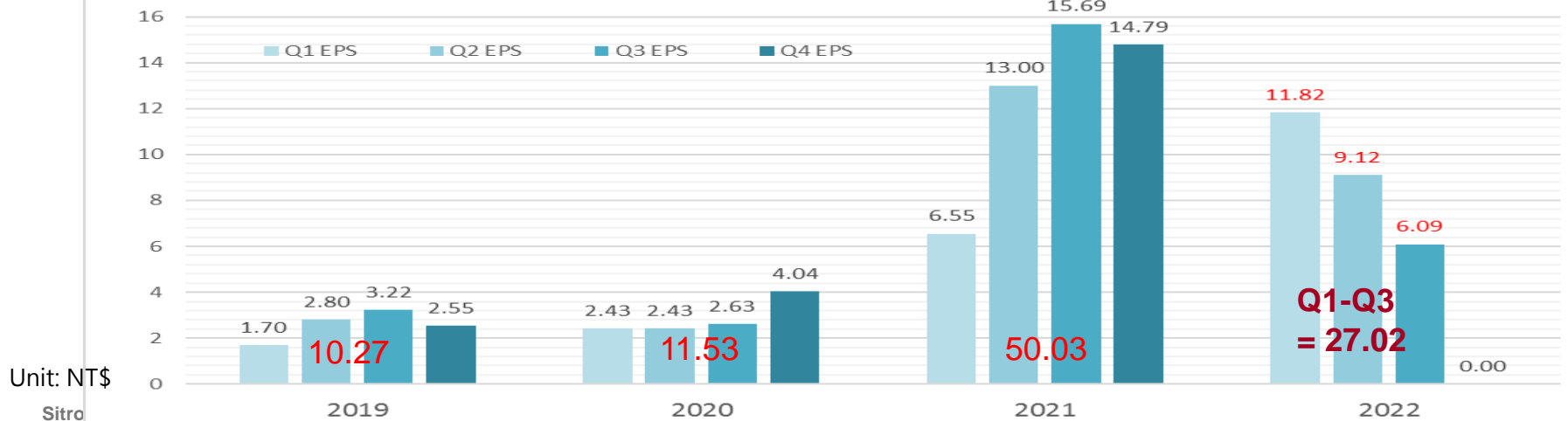
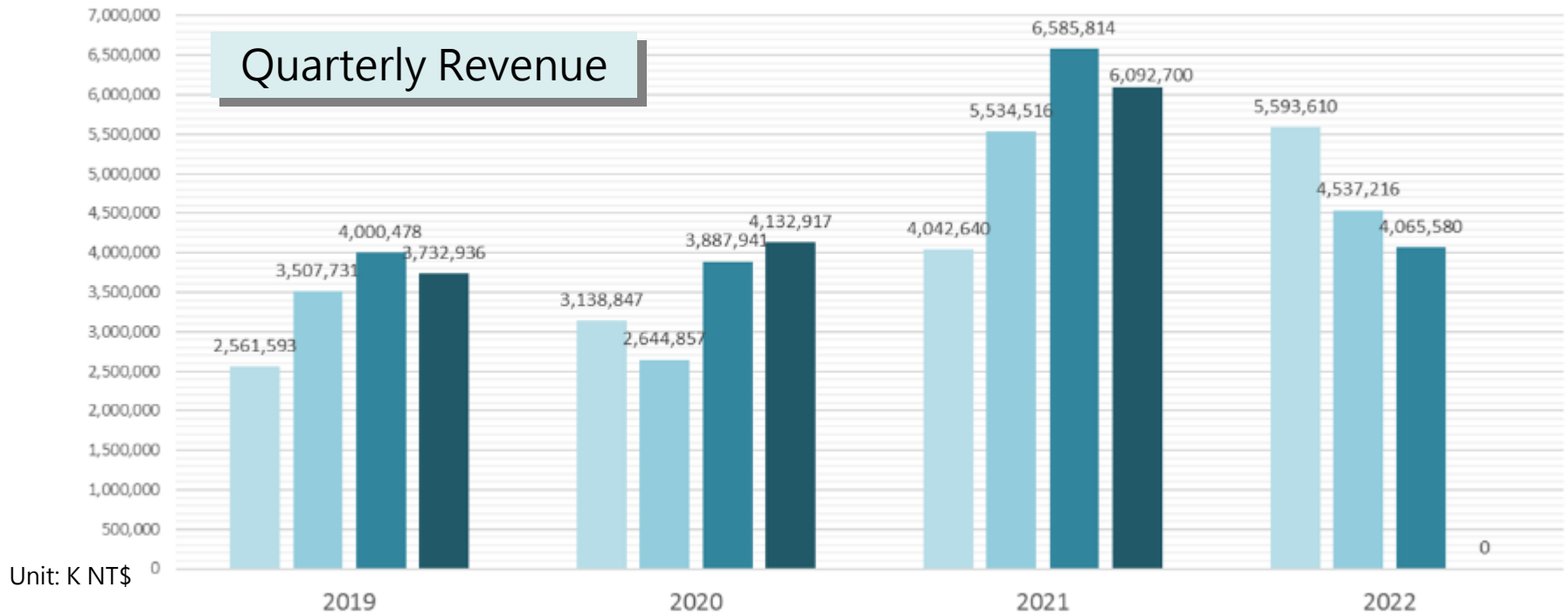

產品組合佔比

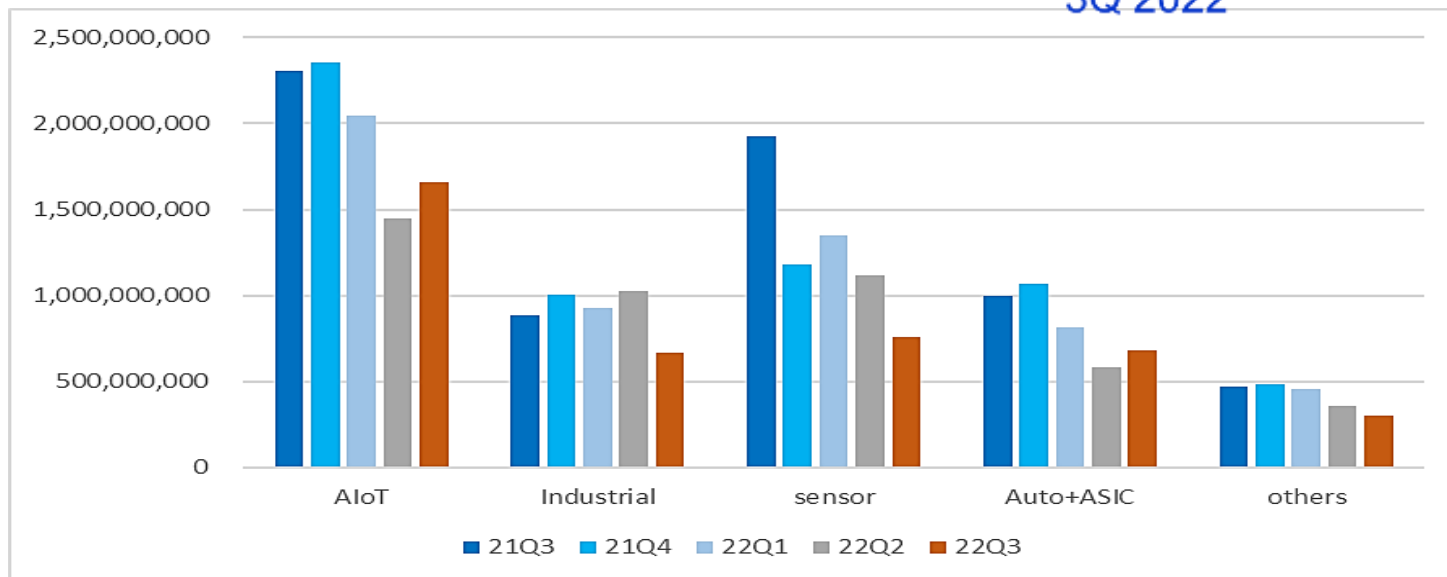
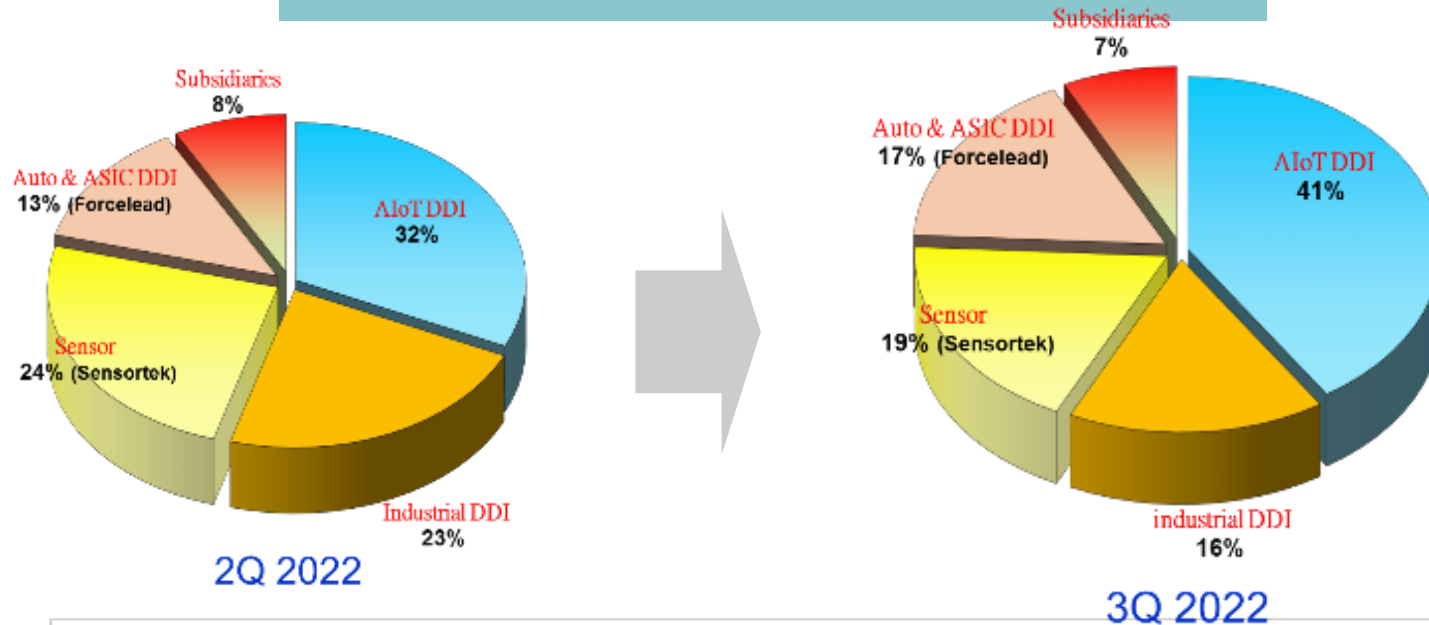

8016 損益表

Item	Q1-Q3 22		Q3 22		Q2 22		Q1 22		Q1-Q4 21		Q3 21	
	Results	% of sales	Results	% of sales	Results	% of sales	Results	% of sales	Results	% of sales	Results	% of sales
Net Sales	14,196,406	-	4,065,580	-	4,537,216	-	5,593,610	-	22,255,670	-	6,585,814	-
Gross Profit	7,109,126	50%	1,698,416	42%	2,399,367	53%	3,011,343	54%	12,351,136	56%	3,799,273	58%
Operating Expense	2,839,805	20%	826,099	21%	949,965	21%	1,063,741	19%	4,202,687	19%	1,216,581	19%
Operating Income	4,270,247	30%	872,574	21%	1,449,773	32%	1,947,900	35%	8,156,897	37%	2,584,478	39%
Income before Tax	4,633,993	33%	1,015,616	25%	1,550,841	34%	2,067,536	37%	8,353,772	38%	2,649,223	40%
Net Income*	3,241,487	23%	729,707	18%	1,093,893	24%	1,417,887	25%	6,005,760	27%	1,883,701	29%
EPS	27.02	-	6.09	-	9.12	-	11.82	-	50.03	-	15.69	-

Unit: NT\$ thousands (except EPS)

Accounting standard: IFRS

* Listed on the English translation of our financial statements as "Profit (loss), attributable to owners of parent"

8016 資產負債表

Item	2022/9/30	2022/6/30	2022/3/31	2021/12/31	2021/9/30
Total Assets	21,141,966	24,853,650	25,874,023	22,672,777	19,949,309
Current Assets	15,828,680	19,577,920	21,049,198	18,086,920	16,051,297
Cash & Equivalents	5,671,209	10,146,771	9,953,822	7,930,508	7,951,964
AR	1,561,067	1,631,276	2,086,052	1,952,110	1,902,991
Inventory	5,597,993	5,057,980	3,418,072	2,450,568	1,995,865
Total Liability	6,815,479	11,470,389	13,659,083	7,475,710	6,968,459
AP	2,079,144	3,118,678	2,868,209	2,480,335	2,291,092
Shareholder Eq.	14,326,487	13,383,261	12,214,940	15,197,067	12,980,850

Unit: NT\$ thousands
Accounting standard: IFRS

AIoT裝置顯示器驅動 ICs

Small-sized a-Si DDIC

... 1-3 inch displays

2018: 500M pcs
2019: 400M pcs
2020: 300M pcs



Mid-sized a-Si DDIC

... 4-6 inch displays

2018: > 130M pcs
2019: > 250M pcs
2020: > 320M pcs

Tablet & Touch & POS & industrial <ul style="list-style-type: none"> WXGA Tablet HD Tablet FHD Tablet 	Work From Home <ul style="list-style-type: none"> Projector Printer Sound Station
Wearable <ul style="list-style-type: none"> QQVGA for Band QVGA for Watch OLED for Band & Watch 	Outdoor & Automotive <ul style="list-style-type: none"> Sport Cams Navigator Aerial camera CSD / HUD E-mirror Cluster / Knob
Medical <ul style="list-style-type: none"> WVGA for Monitor Portable Medical QQVGA for thermometer 	Smart Home <ul style="list-style-type: none"> WVGA for Echo QVGA for Door lock FHD Tablet
Appendix 行車紀錄器 dashcams	Appendix 智慧音響 smart speakers

Differentiation

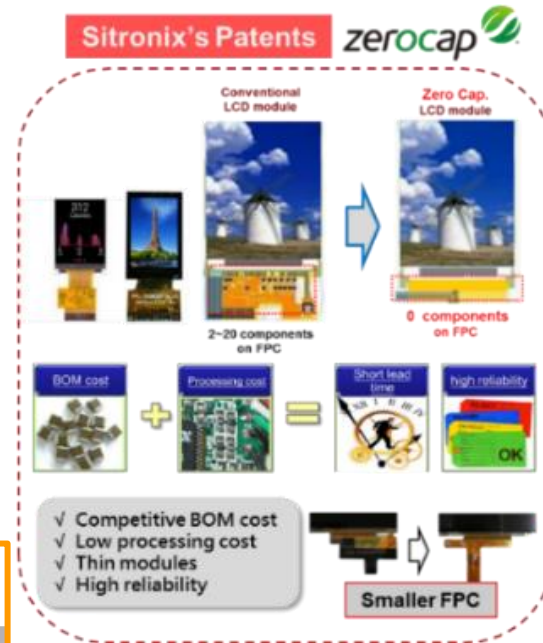

附件照片僅供示意參考
For illustration purposes only.

AIoT DDI application trend :

1. new application growth gradually → with screen from no screen
新應用品類持續增加 ...無屏到有屏
2. screen size get bigger gradually → more larger screen from small screen
顯示器規格持續升級 ...小屏到大屏
3. zero cap. small-sized AMOLED DDI → for wearable devices
4. zero cap. TDDI (HD) → for AIoT & smartphone application

工控類顯示器驅動 ICs

Diversification

TN / STN / mono TFT / color TFT / PMOLED



附件照片僅供示意參考
For illustration purposes only.

Industrial DDI application trend :

1. new applications & market scale growth gradually
新應用終端品類及規模持續增加.
2. keep supported wide display tech. & resolutions
持續擴增支援顯示技術及尺寸規格.
3. ultra low power DDI (a-Si) for low power applications

Ultra Low Power a-TFT Drivers
for low power applications
IoT, wearable devices, e-payment...



Auto Display Driver ICs

Diversification

< 6 inch displays

7 - 12 inch displays

Instrument Cluster Display

- Analog: No Display
- Hybrid (Analog + Digital): Meters
- Full Digital: Virtual Cockpit

Automobile Monitors

- Multi-Function CSD
- Display Audio
- Climate Control
- Rearview Mirror Display
- Overhead Monitor
- Twin CSDs Display Audio + Navigation
- Dual Headrest

- Segment TN
- Character TN
- Graphic STN
- Mono TFT
- Color TFT



Auto DDI trend :

1. EV & PHEV DDI shipment growth gradually
2. keep supported wide display tech. & lager resolution solution

參考附件僅供示意參考
For illustration purposes only.

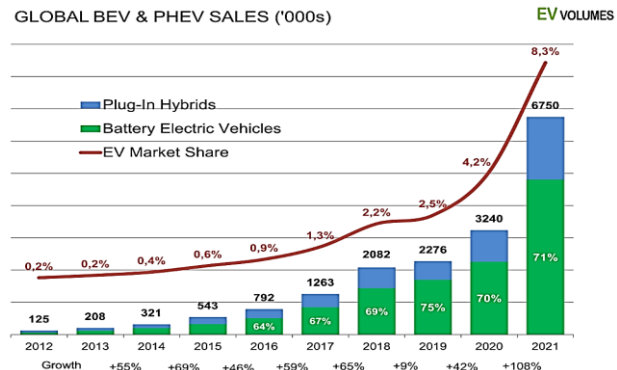

光學感測晶片 - I

Optical sensor for displays :

Proximity Sensors (PS)

近接感測晶片 → 關屏防誤觸
turns off the display (anti-touch)



Ambient Light Sensors (ALS)

環境光感測晶片 → 調節螢幕亮度
... screen brightness control

G1: PS + ALS 2-in-1 visible solution (2010)

G2: PS + ALS 2-in-1 invisible solution (2018)

- Under-display 屏下方案 for AMOLED displays
- Slit type 狹縫方案 for TFT displays

Color temperature Sensors (RGB)

色溫感測晶片 → 調節螢幕色溫
... screen color temperature control

G3: PS + RGB sensors (2019)

G4: PS + RGB sensors (2021)

- Slit type & under display
- for better reading experience

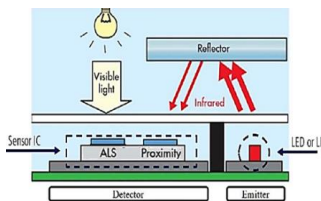

Waterdrop Screen

狹縫(Slit) ALS/PS
狹縫(Slit) PS / 屏下 ALS
前攝旁 ALS/PS
(Aside of Front Facing Camera)



Bezel-less Screen

屏下(Under-display) ALS/PS
狹縫(Slit) PS / 屏下 Under-display ALS



附件照片僅供示意參考
For illustration purposes only.

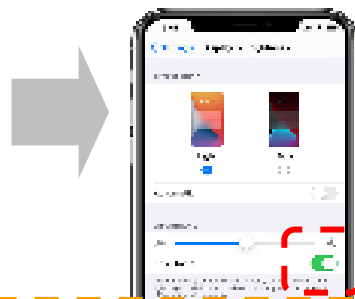

Sensitivity upgrades → ASP Boosts
(感度提升 → 價格提升)

G2: PS + ALS invisible solution

→ 6x (2020) → 10x (2021) → 15x (2022 MP) → 20x under development

- under display solution for AMOLED screen → multi emitter solution or enhance Rx PD sensitivity solution
- white spot reduce solution for AMOLED screen → multi emitter solution or InP (1300nm) PS+ALS solution

G4: PS + RGB invisible solution → 2022 MP ...

光學感測晶片 - II

Optical sensor for Cameras :

3ch RGB sensor (2021 MP)

色溫感測晶片 → 協助後相機白平衡校正
white balance correction

Flicker detection sensors (2021 MP)

閃頻偵測晶片 → 協助消除光源物理閃爍
Flicker detection



→ Flicker + UV detection (ready for MP)



3ch RGB sensor :

Camera RGB sensors are used for **white balance correction**.

Different light sources come with different color temperatures, which can create unrealistic color casts in photos. White balance is the process of removing such color casts so that objects that appear white in person are rendered white in the photo..

環境中充斥著各種不同的光線，這些光線有著不同的色溫，因此手機數位相機在進行拍照時，需要對這些光線進行校正，才能呈現出正常的白色。依據 RGB 色溫感測器、影像感測器所測量的色溫來自動校正調整白平衡。



Flicker detection sensors :

Detects the 50 Hz or 60 Hz flickers produced by incandescent or fluorescent lights. Helps eliminate the streaks and distortion effects caused by the flickering.

檢測環境中由白熾燈或螢光燈所產生的50Hz或60Hz光源物理閃爍。協助手機攝像頭之圖像系統消除人造光源的閃爍而出現的條紋和失真效果。

MEMS 微機電感測晶片

Accelerometers (G-sensors)

Rotation detection

加速度感測器 → 偵測屏幕旋轉方向

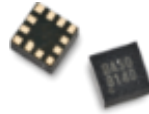

- ✓ G-sensors for smartphones
- ✓ Low power g-sensors for wearable & IoT devices

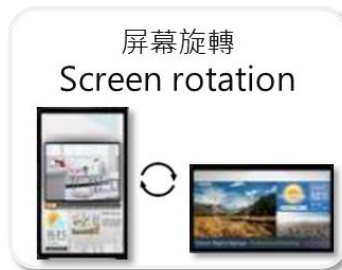

附件照片僅供示意參考
For illustration purposes only.

Barometric pressure sensor -- ready for MP

Atmospheric pressure detection

大氣壓力感測器 → 海拔高度(水深)感測

Gyroscope sensor -- under development

Angular Momentum detection

角動量感測器 → 方向感測與方向維持應用

更多感知器參與智慧手機應用

We are developing high-performance products and moving to high-end

2010 - 2018

2019 – 2022 / 23

Entry-Level

Mid range

High end

Flagship

Addressable Market
400-500M/year

Addressable Market
400-500M/year

Addressable Market
300-400M/year

Addressable Market
300-400M/year

Opticals for Displays
Slit type
ALS only

Opticals for Displays
Slit type
PS(IR LED)+ALS

Opticals for Displays
Slit type
PS(IR LED)+ALS
Under display
PS(VCSEL)+ALS

Opticals for Displays
Under display
PS(VCSEL)+ALS
PS(InP)+ALS
PS(VCSEL)+RGB

MEMS
Accelerometers

+ Pressure sensor

Opticals for Cameras
Flicker sensors

MEMS
Accelerometers
+ Gyroscopes
+ Pressure sensor

Opticals for Cameras
RGB + flicker sensors

MEMS
Accelerometers
+ Gyroscopes
+ Pressure sensor

Opticals for Cameras
RGB + flicker sensors

MEMS
Accelerometers
+ Gyroscopes
+ Pressure sensor

敬請期待

More than 20 sensors built in high-end smartphones

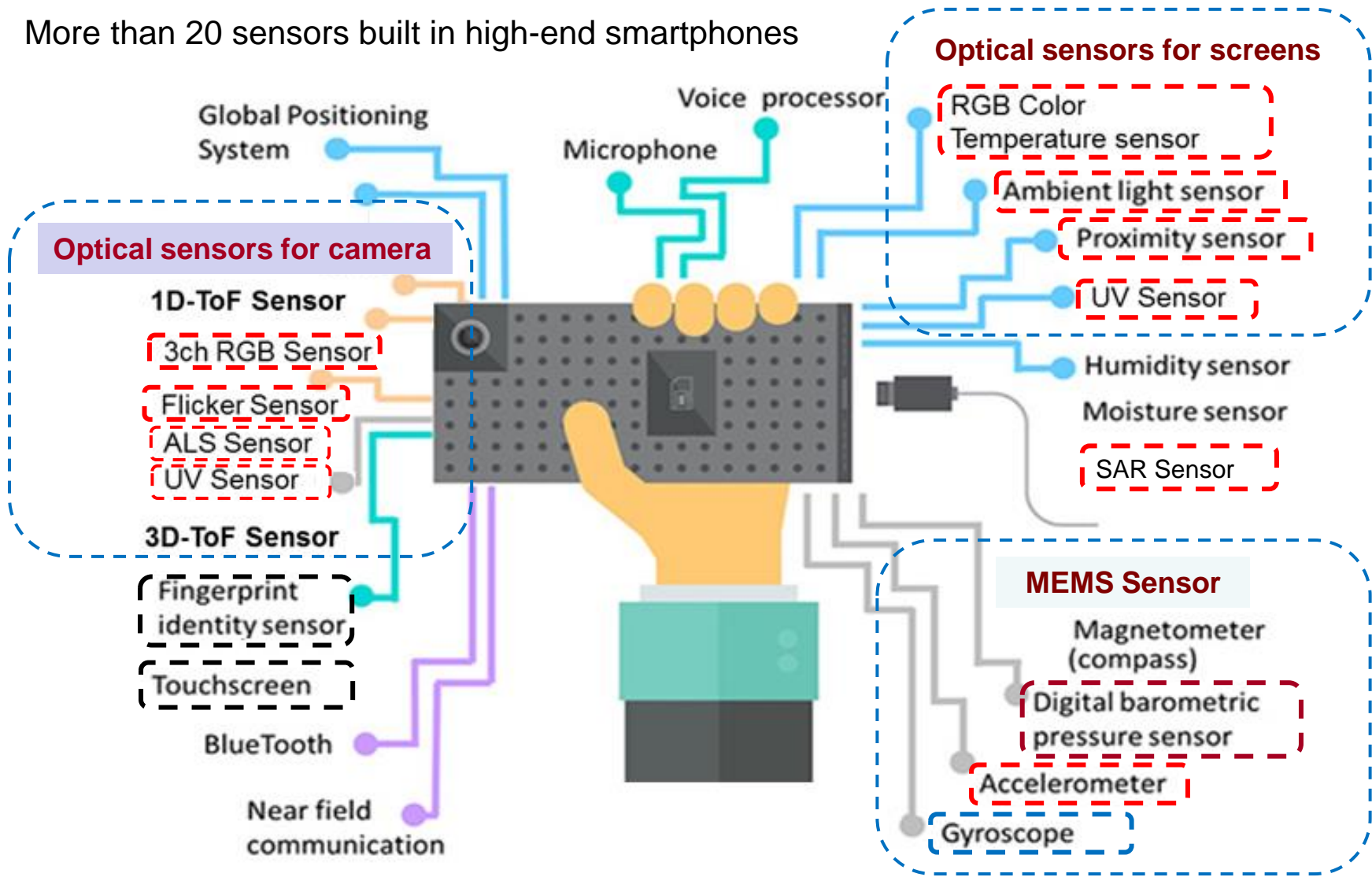

穿戴式裝置： 顯示器IC + 光學感測器 + MEMS + 觸控IC

True wireless stereo (TWS) earbuds

Accelerometers → click detection 敲擊偵測

Proximity sensors → on/off switch 功能啟用開關

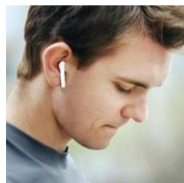

敲擊偵測 Click detection

- 有來電時 Incoming call
單擊接聽 Click to answer
雙擊拒接 Double click to reject
- 音樂播放 Music mode
單擊暫停 Click to pause
雙擊換曲 Double click to switch



Gesture control



On/off control



Proximity detection (ELA)



Ambient dimming control (Smart speaker)



Smart watches & fitness trackers

Accelerometers → motion detection 移動偵測

Optical sensors → heartbeat detection 心律偵測 & UV sensors 紫外線感測



運動偵測 / 計步 Motion detection

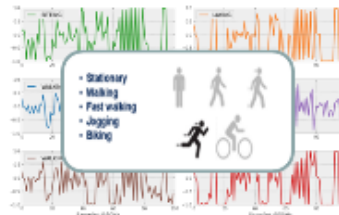

抬手亮屏 / 動態心率輔助 Heartbeat detection



睡眠偵測 / 久坐提醒 Sleep quality monitoring



支持 AIoT 相關解決方案



AIoT

AMADA **Mazak** **Makita** **HITACHI** **Continental** **TOYOTA** **FERRARI** **Mercedes-Benz** **BMW** **HYUNDAI**

BOSCH **Panasonic** **cms electronics** **SIEMENS** **TOKYO ELECTRON** **MITSUBISHI ELECTRIC** **VW** **MITSUBISHI** **VOLVO** **SKODA**

NISSEI **PHILIPS** **KEYSIGHT TECHNOLOGIES** **OMRON** **EPSON** **BRAUN** **Schneider Electric** **Honeywell** **CITIZEN** **BHTC** **YAMAHA**

SAMSUNG **dyson** **SONY** **TCL** **Midea** **amazon** **LG** **Electrolux** **NEC** **TOTO** **Google** **DENSO** **ALPSALPINE** **AVAYA** **brother** **LEXMARK** **FUJI XEROX** **Gigaset** **KYOCERA** **Canon** **hp** **LEGO** **GARMIN** **GoPro** **小天才** **TECNO mobile** **LANDI 联迪** **ASUS** **NOKIA** **HUAWEI** **Jio** **Verifone** **Raritan** **Itron** **三星电气** **威胜集团** **mi**

產品策略

多樣化 (Diversification)

提供完整產品綫, 一站式採購服務
One-stop shopping

分散應用, 分散市場, 降低風險
Risk reduction

高成長+高毛利之產品組合
Balance GM & sales growth

差異化 (Differentiation)

持續創造俱市場競爭力產品
Make existing products better

持續擴展市場滲透率
Market share gains

持續孵化新產品
Incubated new products

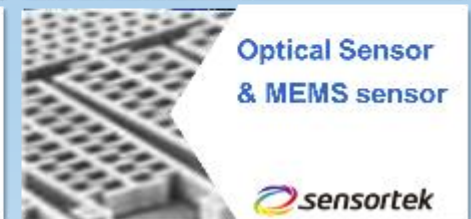

We'd love to hear from you!

Investor Relations Officer

Tom Huang

Tel: +886-2-2659 1276 ext 2255

E-mail: tom_huang@sitronix.com.tw

Website: <http://www.sitronix.com.tw>

Taipei office:

6F., No. 608, Ruiguang Rd., Neihu Dist., Taipei City 114, Taiwan

台北市內湖區瑞光路608號6樓

Lighting up your life.

Sitronix