

Investor Conferences

3Q 2022

Sitronix Technology Corp.

矽創電子股份有限公司

8016: TT

Sitronix

Sitronix Confidential. Do Not Copy or Distribute.

Disclaimer Statement

- This presentation includes forward-looking statements. All statements, other than statements of historical facts, that address activities, events or developments that Sitronix Corp. expects or anticipates will or may occur in the future (including but not limited to projections, targets, estimates and business plans) are forward-looking statements.
- Sitronix actual results or developments may differ materially from those indicated by these forward-looking statements as a result of various factors and uncertainties, including but not limited to material cost increase, market demand, change in legal, financial and regulatory frameworks, government policies, financial market conditions, and other risks and factors beyond our control.
- Sitronix does not undertake any obligation to publicly update any forward-looking statement to reflect events or circumstances after the date on which any such statement is made or to reflect the occurrence of unanticipated events.

About Sitronix

Company Name	Sitronix Technology Corp.
Established	July 9, 1998
Capitalization	USD 40 million
Chairman and CEO	Vincent Mao
IPO Listing	December 25, 2003 (8016)



Consolidated

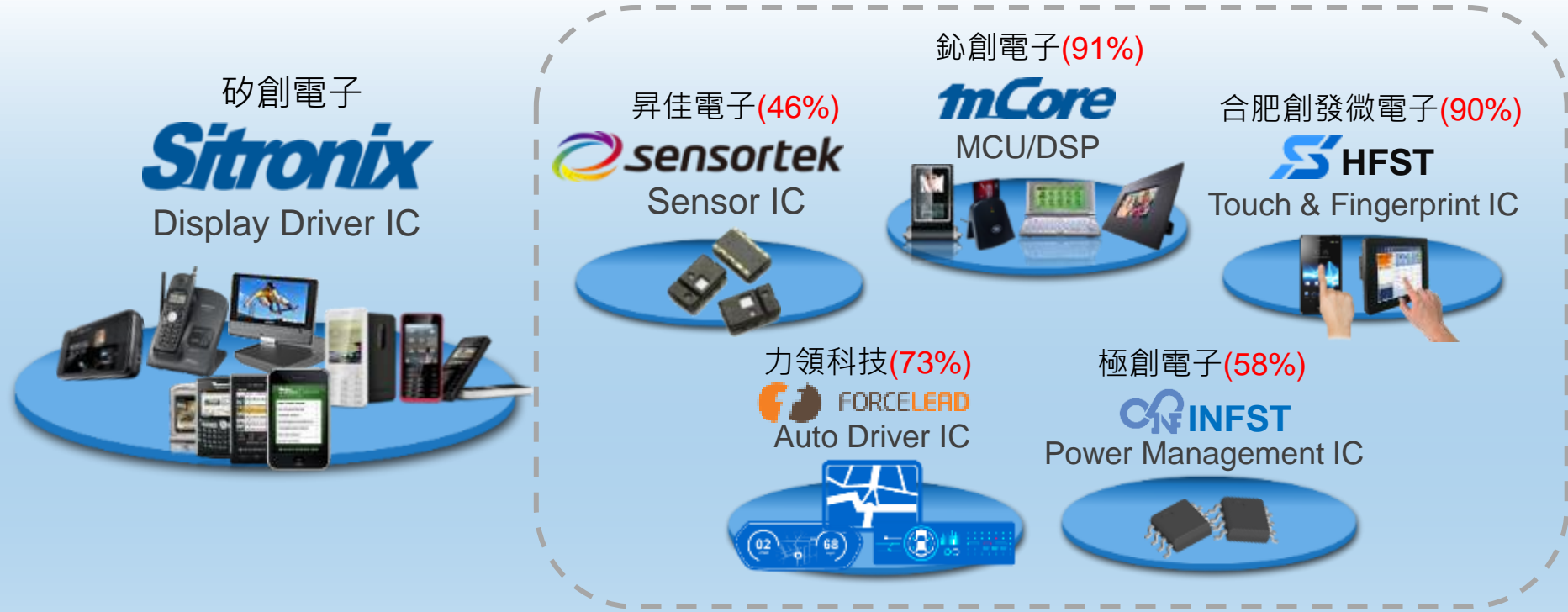

Incubator since 2009

Sitronix Group Revenue

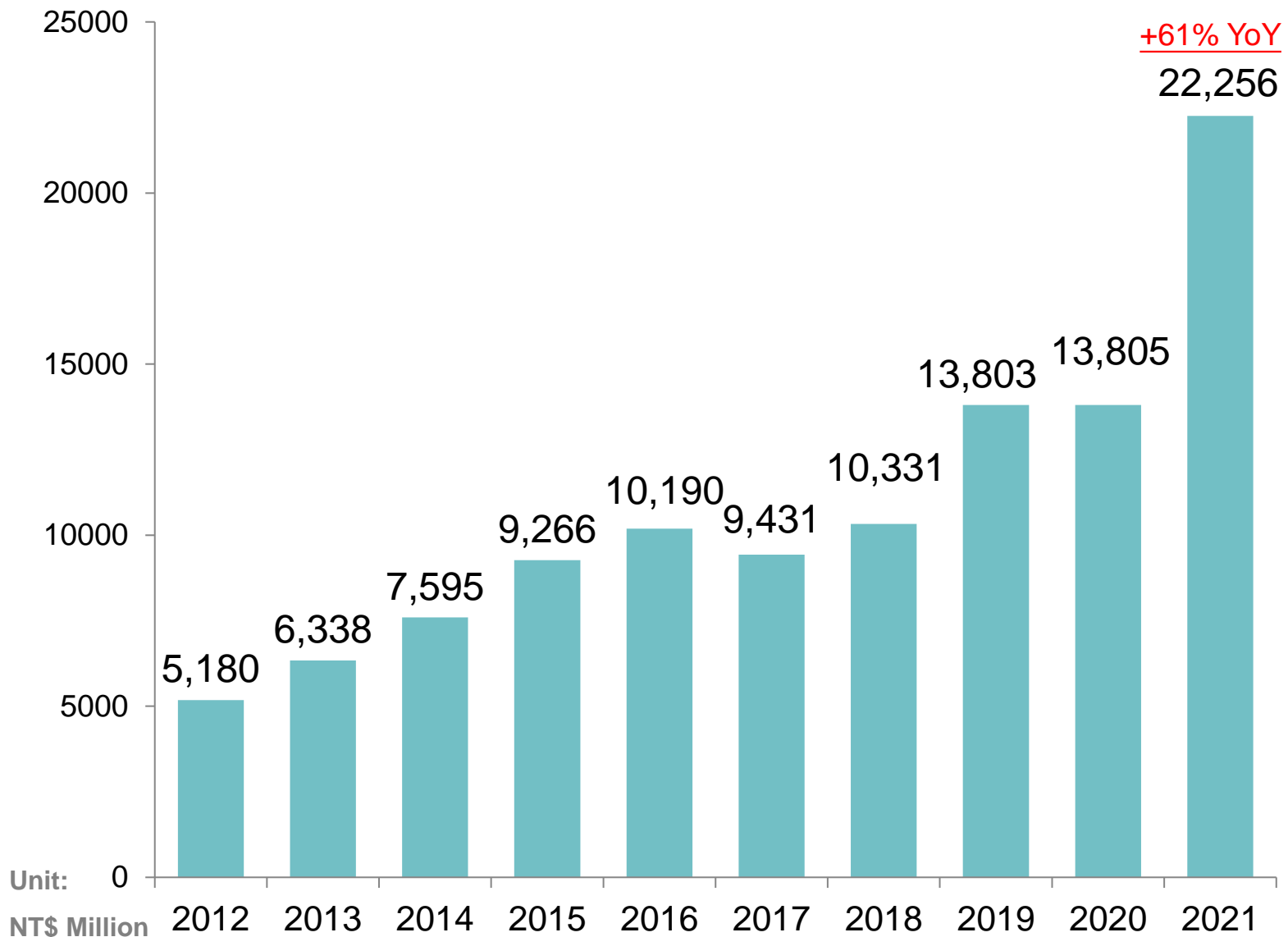

EPS & GM trend

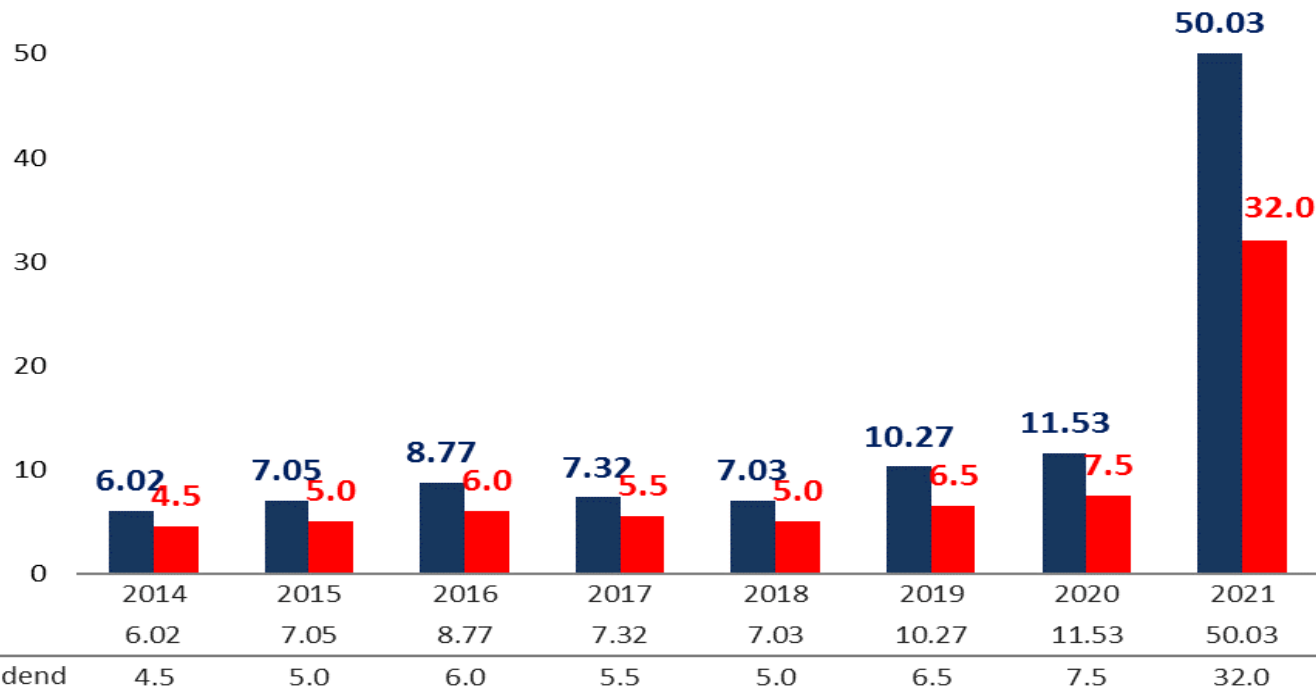
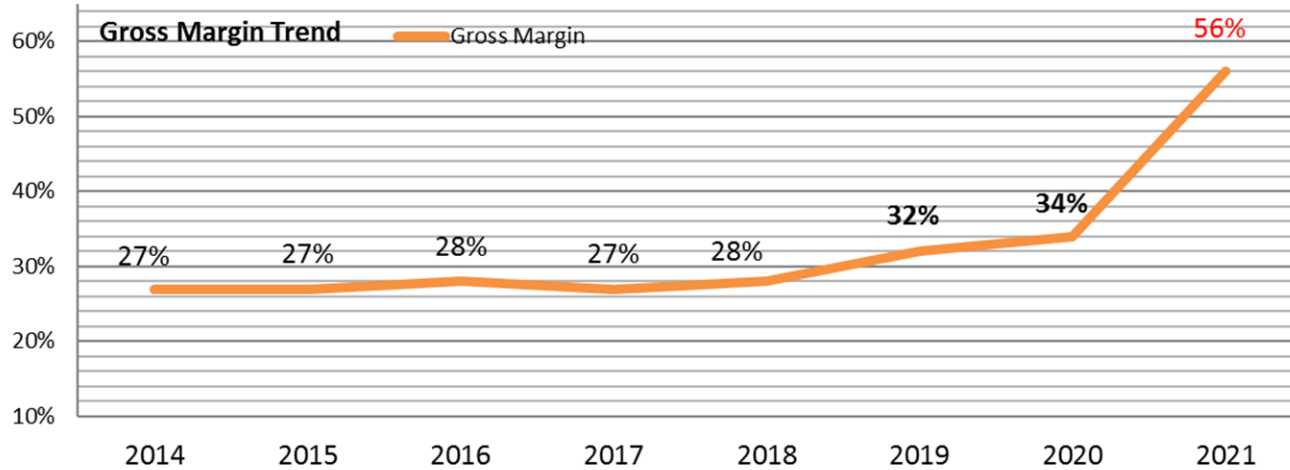

Unit: NT\$
Accounting
standard: IFRS

■ EPS
■ Dividend

Financial Performance

Quarterly Revenue

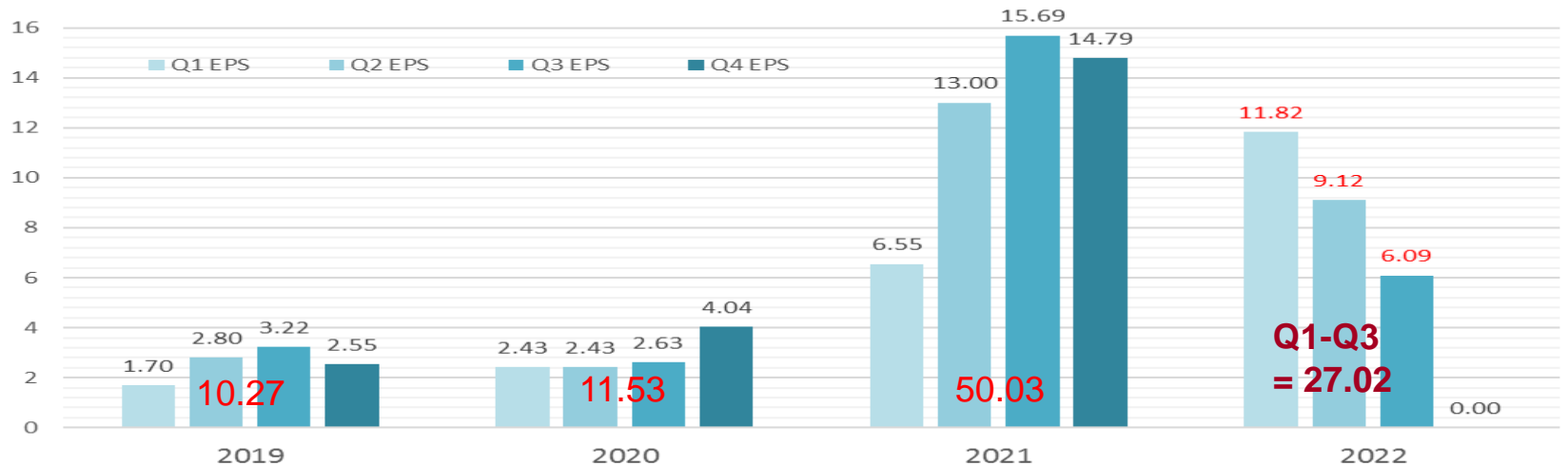
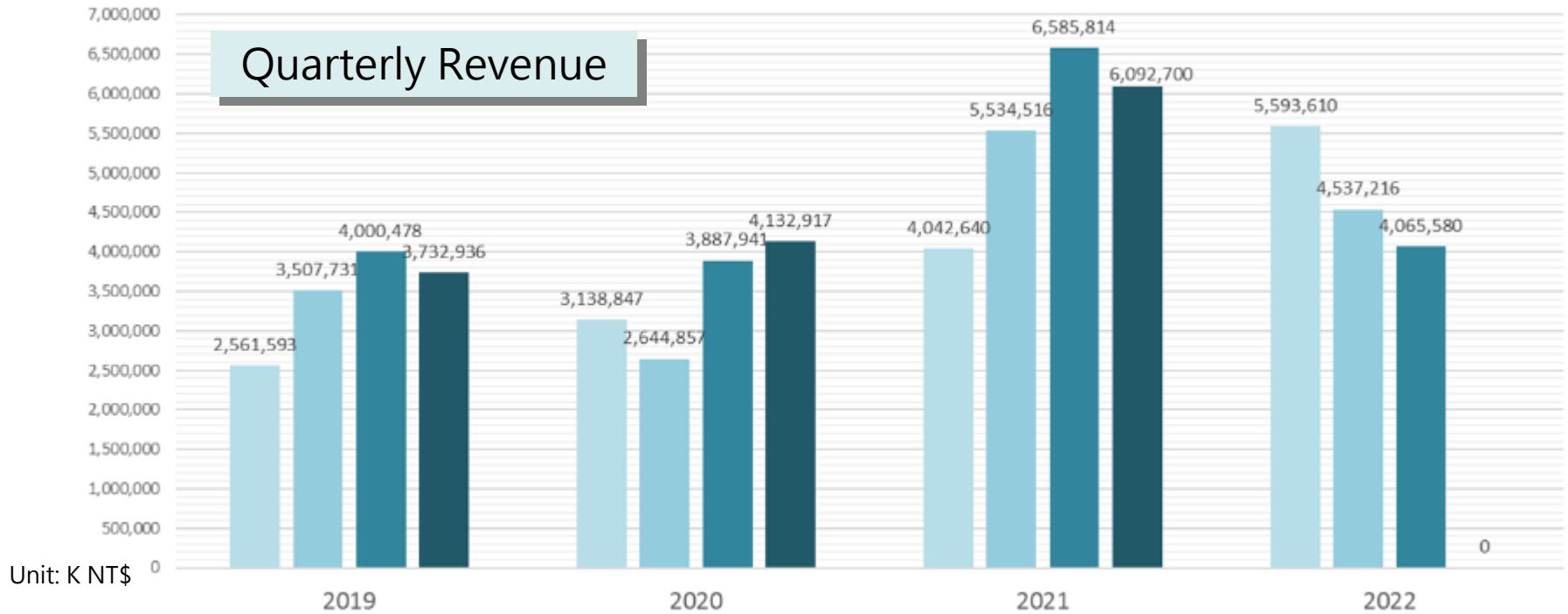

Product Mix

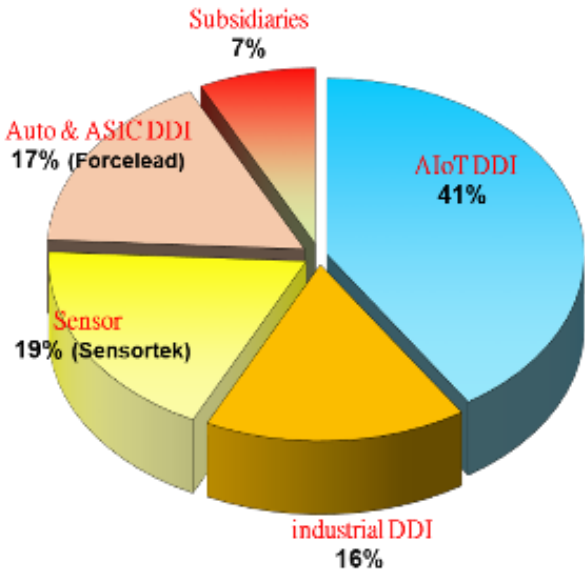

3Q 2022

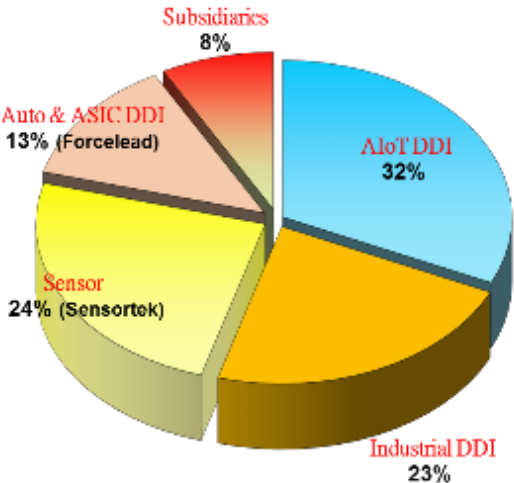

2Q 2022

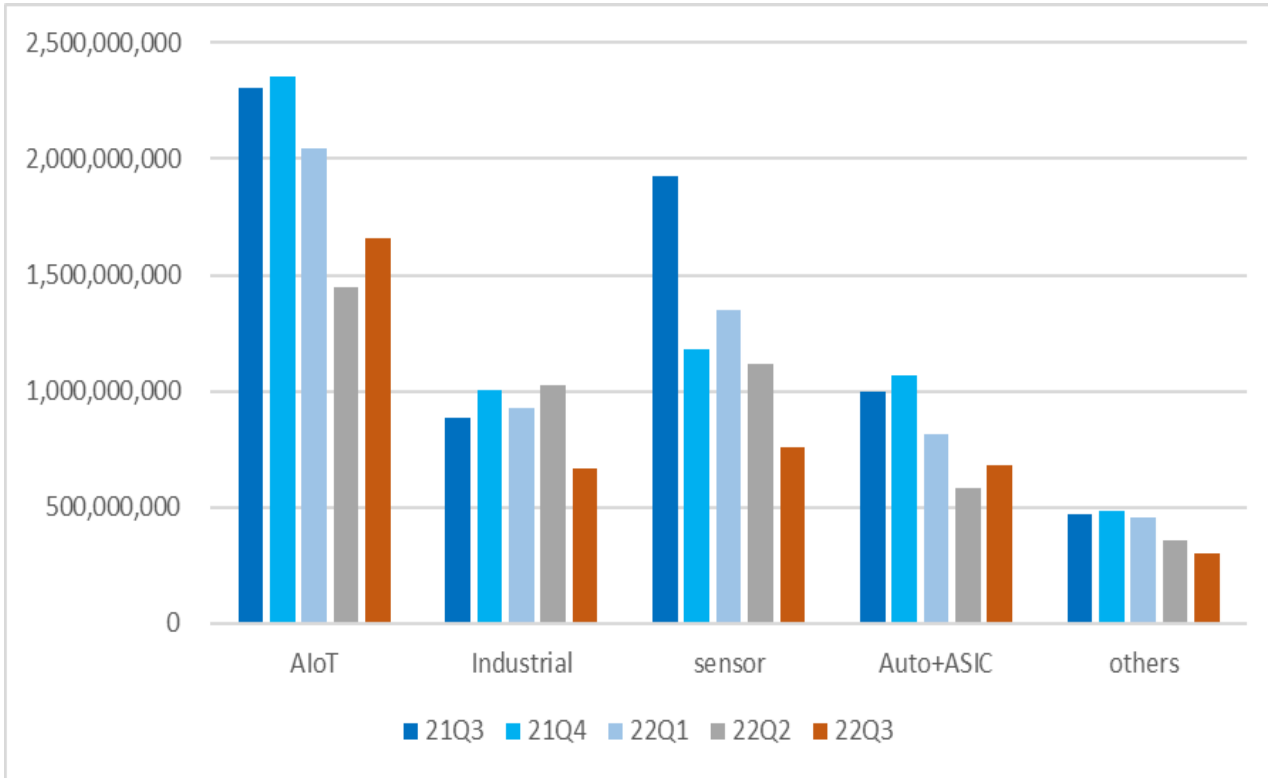

8016 Consolidated Income Statement

Item	Q1-Q3 22		Q3 22		Q2 22		Q1 22		Q1-Q4 21		Q3 21	
	Results	% of sales	Results	% of sales	Results	% of sales	Results	% of sales	Results	% of sales	Results	% of sales
Net Sales	14,196,406	-	4,065,580	-	4,537,216	-	5,593,610	-	22,255,670	-	6,585,814	-
Gross Profit	7,109,126	50%	1,698,416	42%	2,399,367	53%	3,011,343	54%	12,351,136	56%	3,799,273	58%
Operating Expense	2,839,805	20%	826,099	21%	949,965	21%	1,063,741	19%	4,202,687	19%	1,216,581	19%
Operating Income	4,270,247	30%	872,574	21%	1,449,773	32%	1,947,900	35%	8,156,897	37%	2,584,478	39%
Income before Tax	4,633,993	33%	1,015,616	25%	1,550,841	34%	2,067,536	37%	8,353,772	38%	2,649,223	40%
Net Income*	3,241,487	23%	729,707	18%	1,093,893	24%	1,417,887	25%	6,005,760	27%	1,883,701	29%
EPS	27.02	-	6.09	-	9.12	-	11.82	-	50.03	-	15.69	-

Unit: NT\$ thousands (except EPS)

Accounting standard: IFRS

* Listed on the English translation of our financial statements as "Profit (loss), attributable to owners of parent"

8016 Consolidated Balance Sheet

Item	2022/9/30	2022/6/30	2022/3/31	2021/12/31	2021/9/30
Total Assets	21,141,966	24,853,650	25,874,023	22,672,777	19,949,309
Current Assets	15,828,680	19,577,920	21,049,198	18,086,920	16,051,297
Cash & Equivalents	5,671,209	10,146,771	9,953,822	7,930,508	7,951,964
AR	1,561,067	1,631,276	2,086,052	1,952,110	1,902,991
Inventory	5,597,993	5,057,980	3,418,072	2,450,568	1,995,865
Total Liability	6,815,479	11,470,389	13,659,083	7,475,710	6,968,459
AP	2,079,144	3,118,678	2,868,209	2,480,335	2,291,092
Shareholder Eq.	14,326,487	13,383,261	12,214,940	15,197,067	12,980,850

Unit: NT\$ thousands
Accounting standard: IFRS

AIoT Device Display Driver IC

AIoT DDI : 受惠AIoT產品 --

- 新產品品類持續增加 ...無屏到有屏
- 顯示器規格持續升級 ...小屏到大屏

Small-sized DDIC

... 1-3 inch displays

2018: 500M pcs
2019: 400M pcs
2020: 300M pcs



Mid-sized DDIC

... 4-6 inch displays

2018: > 130M pcs
2019: > 250M pcs
2020: > 320M pcs

4G kids' watches



Fitness trackers



Sports cams
Pocket cams



Smart speaker



Payment terminal



Differentiation

Sitronix's Patents **zerocap**

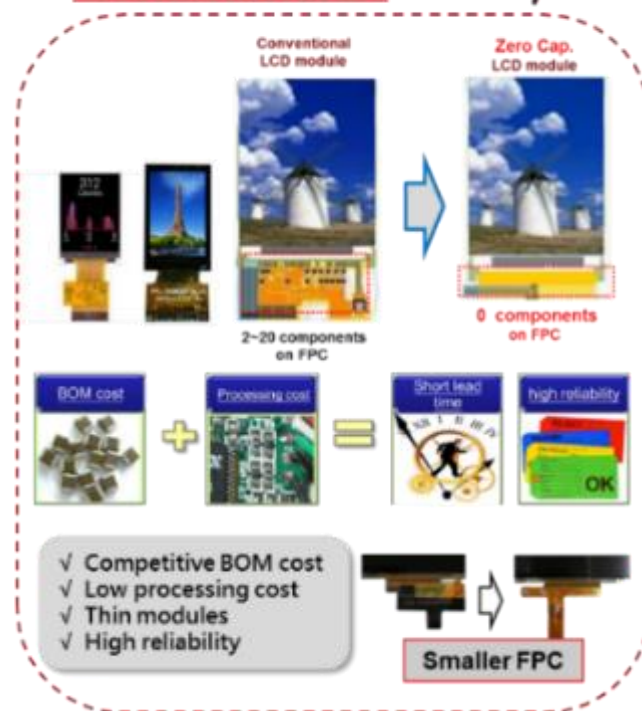

參考附件僅供示意參考
For illustration purposes only.

AIoT applications

Tablet & Touch & POS & industrial

- WXGA Tablet
- HD Tablet
- FHD Tablet



Work From Home

- Projector
- Printer
- Sound Station



Wearable

- QQVGA for Band
- QVGA for Watch
- OLED for Band & Watch



Outdoor & Automotive

- Sport Cams
- Navigator
- Aerial camera
- CSD / HUD
- E-mirror
- Cluster / Knob



Medical

- WVGA for Monitor
- Portable Medical
- QQVGA for thermometer



Smart Home

- WVGA for Echo
- QVGA for Door lock
- FHD Tablet



Industrial Display Driver ICs

Diversification

TN / STN / mono TFT / color TFT / PMOLED



參考附件僅供示意參考
For illustration purposes only.

Ultra Low Power a-TFT Drivers
for new applications
IoT, wearable devices, e-payment...

Wearable Devices



Wearable Products



Auto Display Driver ICs

< 6 inch displays

7 - 9 inch displays

Diversification

Instrument Cluster Display

- Analog No Display
- Hybrid (Analog + Digital) Meters
- Full Digital Virtual Cockpit



Automobile Monitors

- Multi-Function CSD
- Display Audio
- Climate Control
- Rearview Mirror Display
- Overhead Monitor
- Twin CSDs Display Audio + Navigation
- Dual Headrest

- Segment TN
- Character TN
- Graphic STN
- Mono TFT
- Color TFT



參考附件僅供示意參考
For illustration purposes only.

Optical Sensors - I

Optical sensor for displays :

Proximity Sensors (PS)

近接感測晶片 → 關屏防誤觸
turns off the display (anti-touch)

Ambient Light Sensors (ALS)

環境光感測晶片 → 調節螢幕亮度
... screen brightness control

- G1: PS + ALS 2-in-1 visible solution (2010)
- G2: PS + ALS 2-in-1 invisible solution (2018)
 - Under-display 屏下方案 for AMOLED displays
 - Slit type 狹縫方案 for TFT displays

Color temperature Sensors (RGB)

色溫感測晶片 → 調節螢幕色溫
... screen color temperature control

- G3: PS + RGB sensors (2019)
- G4: PS + RGB sensors (2022)
 - Slit type & under display
 - for better reading experience



PS + ALS shipment
2019 : >650M pcs
2020 : >720M pcs
2021 : >660M pcs

Waterdrop Screen

狹縫(Slit) ALS/PS
狹縫(Slit) PS / 屏下 ALS
前攝旁 ALS/PS
(Aside of Front Facing Camera)



Bezel-less Screen

屏下(Under-display) ALS/PS
狹縫(Slit) PS / 屏下 Under-display ALS

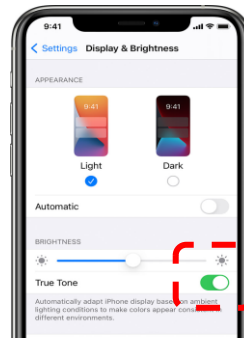

G2: PS + ALS invisible solution → 3x → 6x (2020) → 10x (2021) → 15x (2022 MP)
- Under-display solution for AMOLED

G4: PS + RGB invisible solution → 3x (2022 MP)

Sensitivity upgrades → ASP Boosts
(感度提升 → 平均價格提升)

Optical Sensors -II

Optical sensor for Cameras :

3ch RGB sensor (2021 MP)

色溫感測晶片 → 協助後相機白平衡校正
white balance correction

Flicker detection sensors (2021 MP)

閃頻偵測晶片 → 協助消除光源物理閃爍
Flicker detection

--→ Flicker + UV detection -- under development



3ch RGB sensor :

Camera RGB sensors are used for **white balance correction**.

Different light sources come with different color temperatures, which can create unrealistic color casts in photos. White balance is the process of removing such color casts so that objects that appear white in person are rendered white in the photo..
環境中充斥著各種不同的光線，這些光線有著不同的色溫，因此手機數位相機在進行拍照時，需要對這些光線進行校正，才能呈現出正常的白色。依據 RGB色溫感測器、影像感測器所測量的色溫來自動校正調整白平衡。



Flicker detection sensors :

Detects the 50 Hz or 60 Hz flickers produced by incandescent or fluorescent lights. Helps eliminate the streaks and distortion effects caused by the flickering.

檢測環境中由白熾燈或螢光燈所產生的50Hz或60Hz光源物理閃爍。協助手機攝像頭之圖像系統消除人造光源的閃爍而出現的條紋和失真效果。

MEMS sensors

Accelerometers (G-sensors)

Rotation detection

加速度感測器 → 偵測屏幕旋轉方向

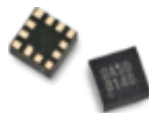

G-sensor shipment

2019 : >55M pcs
2020 : >80M pcs
2021: >120M pcs

- ✓ G-sensors for smartphones
- ✓ Low power g-sensors for wearable & IoT devices



Gyroscope sensor -- under development

Angular Momentum detection

角動量感測器 → 方向感測與方向維持應用

Barometric pressure sensor -- ready for MP

Atmospheric pressure detection

大氣壓力感測器 → 海拔高度(水深)感測

2021: Three Smartphone Sensors

We are developing high-performance products and moving to high-end

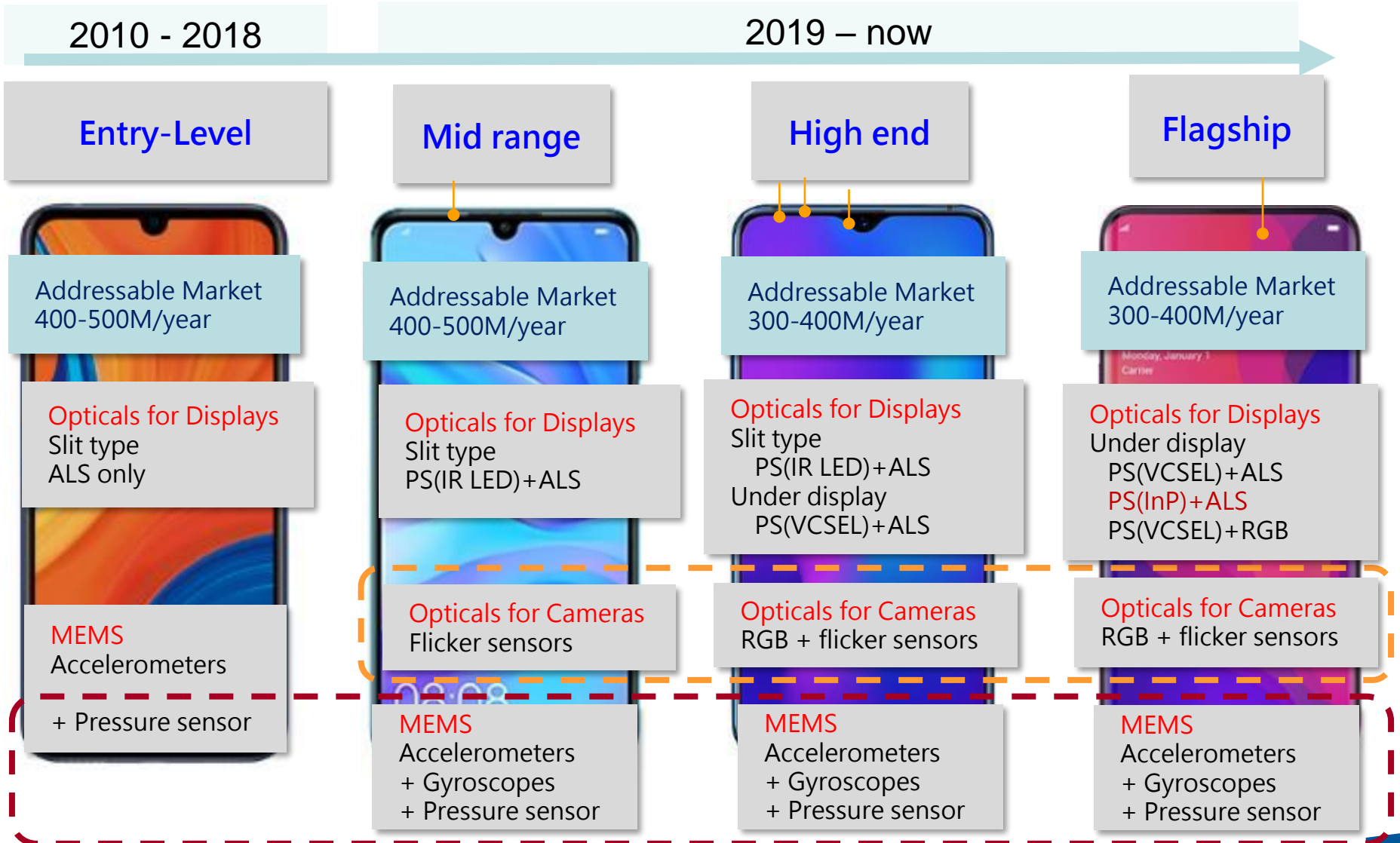

Stay Tuned

More than 20 sensors built in high-end smartphones

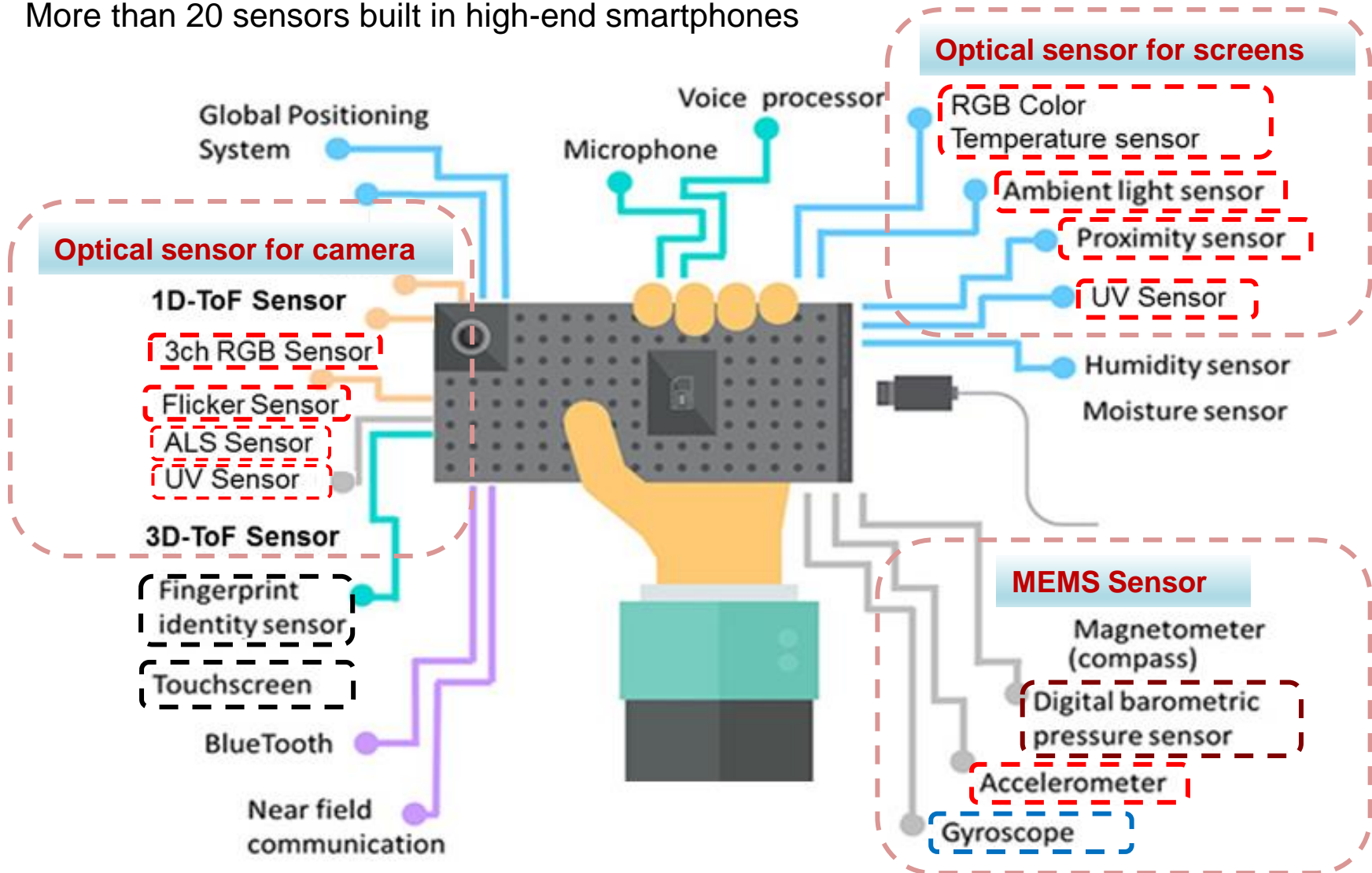

Wearable Devices : DDI + Optical + MEMS + Touch IC

True wireless stereo (TWS) earbuds

Accelerometers → click detection 敲擊偵測

Proximity sensors → on/off switch 功能啟用開關

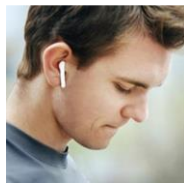

敲擊偵測 Click detection

- 有來電時 Incoming call
單擊接聽 Click to answer
雙擊拒接 Double click to reject
- 音樂播放 Music mode
單擊暫停 Click to pause
雙擊換曲 Double click to switch



Gesture control



On/off control



Proximity detection (ELA)



Ambient dimming control (Smart speaker)



Smart watches & fitness trackers

Accelerometers → motion detection 移動偵測

Optical sensors → heartbeat detection 心律偵測 & UV sensors 紫外線感測



運動偵測 / 計步 Motion detection

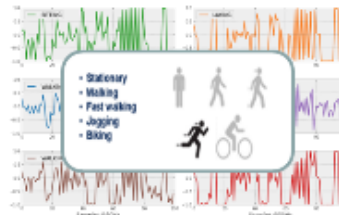

抬手亮屏 / 動態心率輔助 Heartbeat detection



睡眠偵測 / 久坐提醒 Sleep quality monitoring



Support AIoT related solutions



AIoT

AMADA **Mazak** **Makita** **HITACHI** **Continental** **TOYOTA** **Ferrari** **Mercedes-Benz** **BMW** **HYUNDAI**

BOSCH **Panasonic** **VW** **MITSUBISHI** **VOLVO** **SAAB**

cms electronics **SIEMENS** **TOKYO ELECTRON** **MITSUBISHI ELECTRIC** **BHTC** **YAMAHA**

NISSEI **PHILIPS** **DENSO** **ALPS** **ALPINE**

KEYSIGHT TECHNOLOGIES **AVAYA** **brother**

OMRON **LEXMARK**

EPSON **FUJI XEROX**

BRAUN **Gigaset**

Schneider Electric **KYOCERA**

Honeywell **Canon**

CITIZEN **hp** **LEGO**

SAMSUNG **GARMIN**

TCL **dyson** **GoPro**

SONY **小天才** **TECNO mobile**

Midea **amazon** **LANDI 联迪** **ASUS**

LG **Electrolux** **NOKIA** **HUAWEI**

NEC **TOTO** **Google** **Raritan** **Itron** **三星电气** **MI** **Jio** **Verifone**

Our Strategy

多樣化 (Diversification)

提供完整產品綫, 一站式採購服務
One-stop shopping

分散應用, 分散市場, 降低風險
Risk reduction

高成長+高毛利之產品組合
Balance GM & sales growth

差異化 (Differentiation)

持續創造俱市場競爭力產品
Make existing products better

持續擴展市場滲透率
Market share gains

持續孵化新產品
Incubated new products



AIoT Device

- › Smartphone
- › Feature Phone
- › Wearable devices
- › AIoT devices

Industrial

- › Office Automation
- › Industrial Instruments
- › Portable Medical Devices

Automotive

- › Cluster Display
- › Navigation Display
- › Center Information Display

FORCELEAD

Optical Sensor & MEMS sensor

sensortek

We'd love to hear from you!

Investor Relations & ESG Officer

Tom Huang

Tel: +886-2-2659 1276 ext 2255

E-mail: tom_huang@sitronix.com.tw

Website: <http://www.sitronix.com.tw>

Taipei office:

6F., No. 608, Ruiguang Rd., Neihu Dist., Taipei City 114, Taiwan

Lighting up your life.

Sitronix